



GEEPLUS

SH1LF-0730-xx

$$\text{Duty Cycle} = \frac{\text{"on" time}}{\text{"on" time} + \text{"off" time}} \times 100\% \quad 25\% \text{ ED}$$

Coil Data

Maximum "on" time in seconds	10
Watts at 20°C	9,6
Ampere-Turns at 20°C	614

P/N	Resistance ±10% @ 20°C	Coil Turns	Volts DC	Release Current
SH1LF-0730-06	3.8 Ω	385	6	650 mA
SH1LF-0730-12	15.0 Ω	780	12	320 mA
SH1LF-0730-24	60.0 Ω	1530	24	160 mA

General Parameters

Life Expectancy (Cycles)	200 000
Mass	38 grammes
Plunger Mass	9.38 grammes
Leadwires 250mm (10")min, UL1007, AWG26	
Isolation Class	A (105°C)
Dielectric Strength 1000V AC, 50/60Hz, 1min	
Insulation Res >100MΩ, 500V DC Megger	

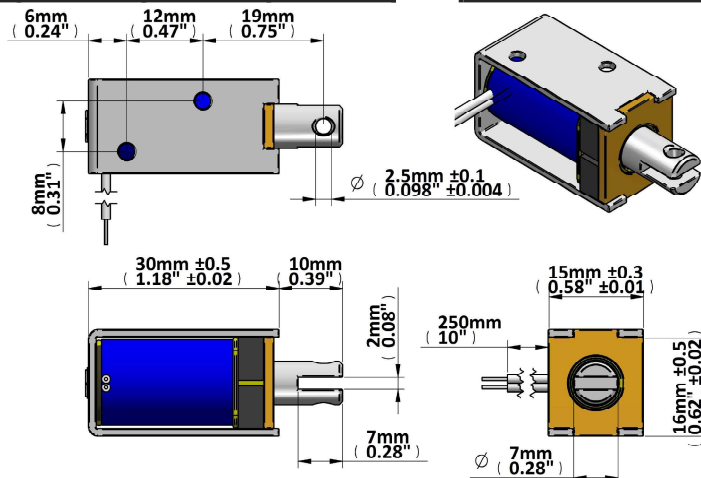

Force (N) vs Displacement (mm) & Release Characteristic

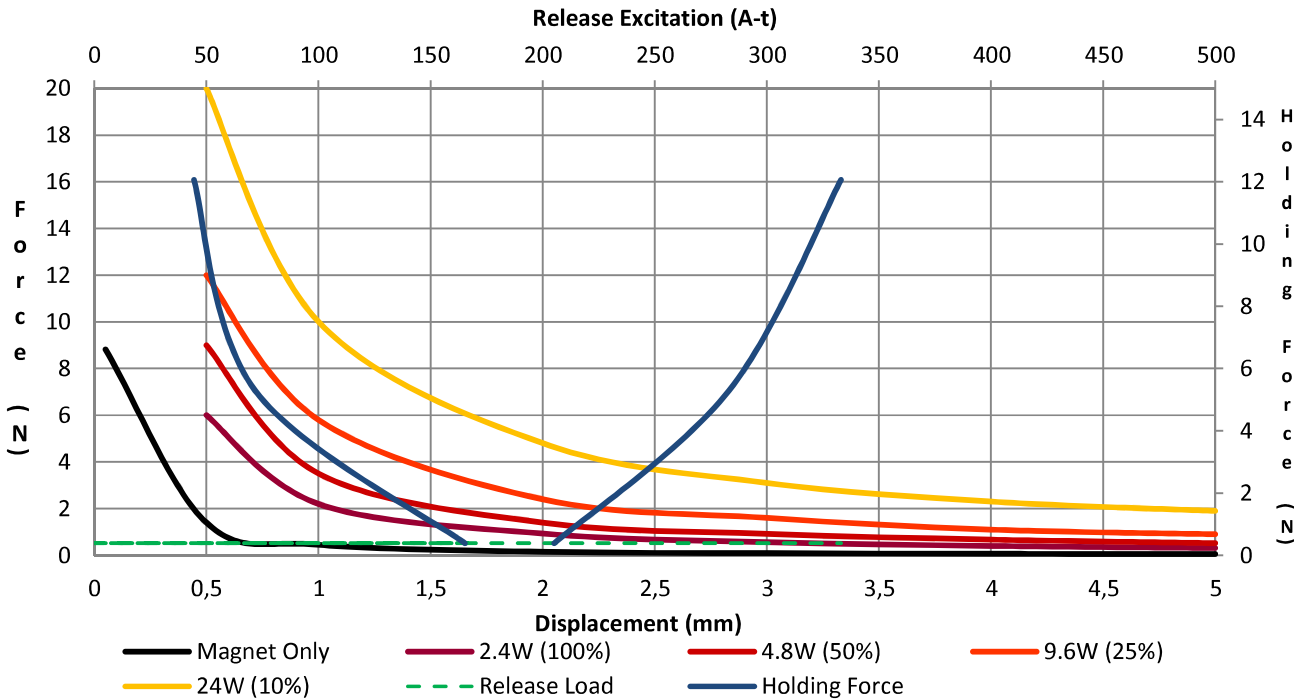

Geeplus reserves the right to change specifications without notice
www.geeplus.com