

# Data Sheet for Angle Sensors

## Optical incremental Kit Encoder

## Series SPEH



- Optical resolution until 1000 pulses per revolution
- 22 mm housing diameter
- 11.3 mm housing depth
- Applicable for shaft diameters from 2 mm to 6.35 mm
- 2 channels A+B
- Supply voltage 5 VDC
- Output TTL or linedriver
- Integrated MOLEX coupling

Very compact kit optical encoder. Thanks to the available mounting tools secure to install. For long shafts a borehole in the rear cover is available.

With the integrated MOLEX plug-in connection, the encoder could be easily connected to the evaluation unit. This improves the handling during installation and service.

Electrical Data	TTL	Line Driver
Output signal	5 V - A, B	differential 3.8 V - A, /A, B, /B
Number of pulses	100..1000 pulses per rev.	
Output voltage high	≥ 2.4 V @ -8 mA with load (4 V @ no load)	≥ 4.75 V @ 25 mA with load (5 V typ. @ no load)
Output voltage low	≤ 0.4 V @ 8 mA with load (0.035 V @ no load)	≤ 0.6 V @ 4.5 mA with load (0.25 V typ. @ no load)
Differential output voltage	-	≥ 3.0 V @ RL = 100 Ω (typ. 3.8 V)
Limit frequency	100 kHz	
Supply voltage	5 VDC ±10 %	
Power consumption (no load)	≤ 30 mA (typ. 25 mA)	≤ 32 mA (typ. 27 mA)
Output capacity	8 mA pro channel (A or B)	
Output electronics	TTL	Line Driver
Switch-on delay	100 ns (rise time) / 50 ns (fall time)	20 ns (rise/fall time)

## Mechanical and Environmental Data, Miscellaneous

Mechanical angle of rotation /stroke 1.)	360° without stop
Max. allowed operational speed	≤ 60.000 rpm (in dependence of the amount of pulses per revolution) Formula for calculation: max. rpm = (100000[1/s] x 60[s]) / pulses per rev.
Max. acceleration	250000 rad/sec <sup>2</sup>
Operating temperature range	-20..+100 °C
Storage temperature range	-20..+100 °C

# Data Sheet for Angle Sensors

Optical incremental Kit Encoder

Series SPEH

## Mechanical and Environmental Data, Miscellaneous

Vibration (IEC 68-2-6, Test Fc)	20 g / 20 bis 2000 Hz / sine-shaped
Shock (IEC 68-2-27, Test Ea)	75 g / 6 ms / halfsine
Housing diameter / length	22 mm
Housing depth	11.5 mm
Shaft diameter	2..6.35 mm
Shaft type	Hub for sold shafts
Permissible axial play	±0.25 mm
Permissible eccentricity + radial play	0.05 mm
Minimum shaft length incl. axial play	7 mm
Maximum shaft length incl. axial play	≤ 10 mm (without borehole in cover) / > 10 mm (with borehole in cover)
Connection type	Molex coupling
Connection position	Radial
Mass	app. 5 g
Fastening parts included in delivery	Mounting tools consisting of a centering tool and a spacer tool
Material housing	Plastic
Material disc	Mylar
Immunity ESD, human body model (MIL-STD-883, Method 3015.8)	± 7 kV (TTL) / ± 12 kV (Line Driver)

1.) According IEC 60393

2.) Determined by climatic conditions according to IEC 68-1, para. 5.3.1 without load collectives

# Data Sheet for Angle Sensors

Optical incremental Kit Encoder

Series SPEH

## Order Code

Description	Selection: standard=black/bold, possible options=grey/cursive						
Series SPEH	SPEH						
<b>Shaft diameter:</b>							
<i>Option 2 mm</i>		2					
<i>Option 2.3 mm</i>		2.3					
<i>Option 2.5 mm</i>		2.5					
<i>Option 3 mm</i>		3					
<i>Option 3.175 mm</i>		3.175					
<b>Standard: 4 mm</b>		<b>4</b>					
<i>Option 5 mm</i>		5					
<b>Standard: 6 mm</b>		<b>6</b>					
<i>Option 6.35 mm (1/4")</i>		6.35					
<b>Resolution in pulses per revolution:</b>							
<b>Standard: 100 ppr.</b>			<b>100</b>				
<i>Option 108 ppr.</i>			108				
<i>Option 120 ppr.</i>			120				
<i>Option 125 ppr.</i>			125				
<i>Option 128 ppr.</i>			128				
<i>Option 200 ppr.</i>			200				
<i>Option 250 ppr.</i>			250				
<i>Option 256 ppr.</i>			256				
<i>Option 300 ppr.</i>			300				
<b>Standard: 360 ppr.</b>			<b>360</b>				
<i>Option 400 ppr.</i>			400				
<i>Option 500 ppr.</i>			500				
<i>Option 512 ppr.</i>			512				
<i>Option 720 ppr.</i>			720				
<i>Option 800 ppr.</i>			800				
<i>Option 1000 ppr.</i>			1000				
<b>Supply voltage</b>							
<b>Standard: 5 V</b>				<b>5</b>			
<b>Output signal</b>							
<b>Standard: A+B</b>					<b>B</b>		
<b>Output electronics:</b>							
<b>Standard: TTL</b>						<b>TTL</b>	
<i>Option Line Driver differential</i>						N	
<b>Back cover:</b>							
<b>Standard: closed (without borehole in back cover)</b>							<b>A</b>
<i>Option without borehole in back cover for longer shafts</i>							B

## Order example SPEH

### Requirement:

Shaft diameter 6 mm, resolution 100 pulses per revolution, supply voltage 5 V, 2 channels A+B, output electronics TTL, back cover without borehole for longer shafts

**Example for order code: SPEH 6 100 5 B TTL A**

# Data Sheet for Angle Sensors

## Optical incremental Kit Encoder

Series SPEH

For higher quantities or on-going demand, additional options are available as described below

For example:

- Other hub diameters for other shaft diameters
- Special connector and cable design

## Technical Drawing

TTL Version

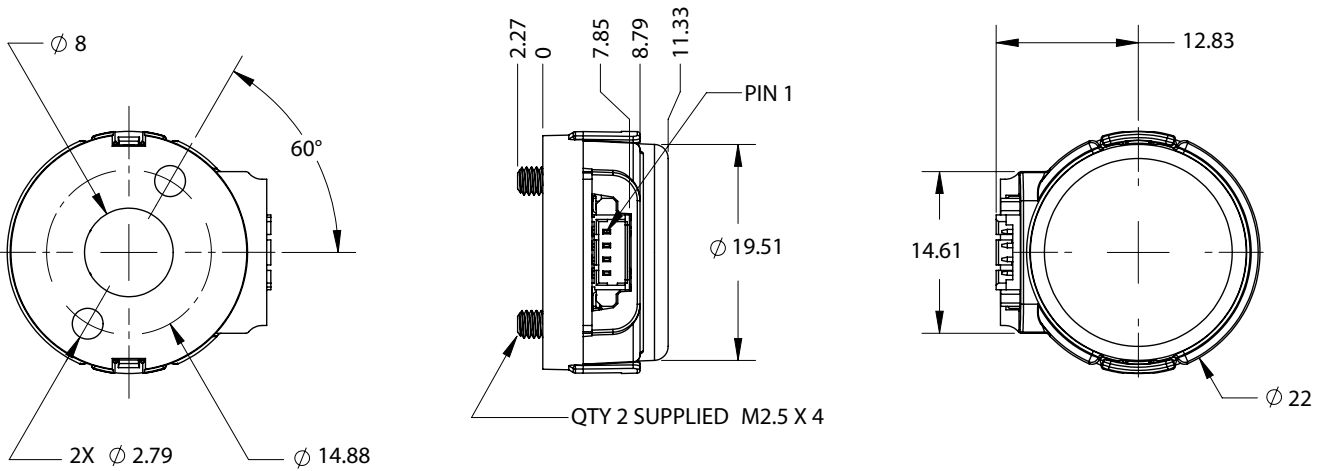

Line Driver Differential Version

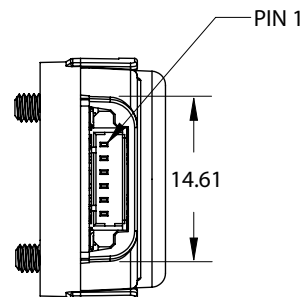

TTL Version

Mating connector  
Housing: Molex # 51021-0400  
Pins: Molex # 50079-8100

Accessory - not included in delivery:  
Mating connector with 500 mm AWG28 leads

Line Driver Differential Version

Mating connector  
Housing: Molex # 51021-0600  
Pins: Molex # 50079-8100

Dimensions in mm

Option: Cover Hole for Extended Shafts

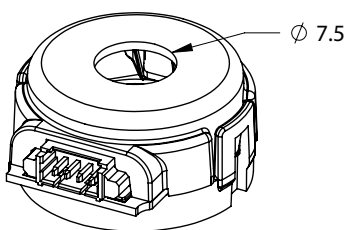

Connection diagram

	TTL	Line Driver
PIN 1	+5 VDC	Ground
PIN 2	Channel A	Channel A
PIN 3	GND	Channel A/
PIN 4	Channel B	+5 VDC
PIN 5	not existing	Channel B
PIN 6	not existing	Channel B/

Output waveform

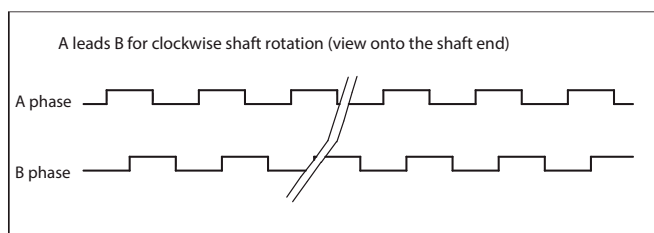

## Assembly instruction

**The ESD guidelines must be followed during transport, storage, assembly and operation. Avoid touching the optical sensor and the optical disc in the area of the increments.**

### Step 1:

Place the base over the shaft and onto the mounting surface. Slide the centering tool onto the shaft so that it contacts and aligns the base. While applying light pressure to the centering tool, secure the base to the mounting surface using two screws.

Mounting Screws:  
≤ 0,3 Nm

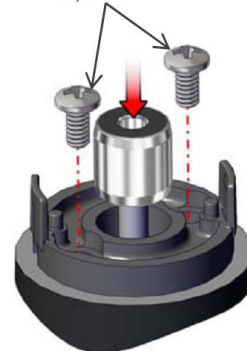

### Step 2:

Remove the centering tool and place the PCB onto the base, aligning the hole and slot to the two pins on the base. Note that the base is symmetrical allowing the connector to exit out either side.

**Caution:** When handling the PCB it is best to avoid directly touching the optical sensor.

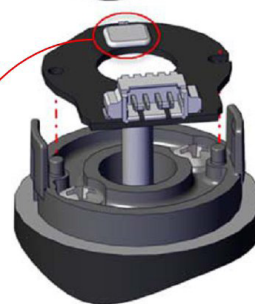

### Step 3:

Using the spacer tool, very firmly press down on the PCB in order to push it over the alignment pins and completely onto the base surface. Check to make sure that the PCB is fully seated against the base. If it is not, use the spacer tool to press it again, recheck that it is fully seated.

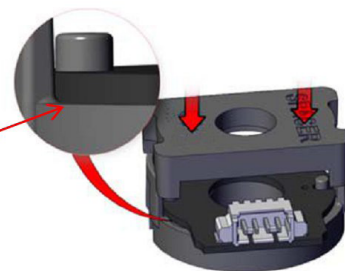

### Step 4:

Place the hubdisk onto the shaft with the longer end of hub toward the base. Position the spacer tool onto the hub such that the notches are aligned with the latches of the base. Press down firmly until the tool bottoms out on the PCB. Verify that this action has pressed the PCB flush against the base.

**Caution:** While installing the hubdisk ensure that the hub bore is parallel to the shaft. Forcing the hub onto the shaft at an angle may cause permanent damage to the hub.



## Step 5:

Remove the spacer tool and snap the cover down onto the base, (1). With your thumb and finger, squeeze the base latches together to ensure they are fully engaged with the cover, (2).

