

# Data Sheet for Precision Potentiometer



TDS Precision Products GmbH  
Industriestrasse 1a  
CH-8157 Dielsdorf

T + 41 44 885 30 80  
info@tds-pp.com  
www.tds-pp.com

## Multiturn Hybrid Potentiometer

## Series AL24



The AL24 potentiometers in 20 mm housing are suitable for applications where a long life span and high-resolution multiturn potentiometer is important.

- Very high-resolution and long-lasting due to hybrid technology
- Very clean signal - no winding jumps thanks to hybrid technology
- With many options e.g. limit switch, slipping clutch

The high-resolution precision potentiometers of the AL24 series have a wire-wound resistor element, which is finished with a conductive plastic layer. Thus the so-called winding jumps are omitted and the resolution is almost infinite. Due to the smooth surface of the resistance element, the hybrid potentiometer has a significantly longer life span than wirewound potentiometers.

Electrical Data	3-turn	5-turn	10-turn
Effective electrical angle of rotation 1.)	1080° ±5°	1800° ±5°	3600° ±5°
Total resistance 1.)	1..50 kOhm		2..100 kOhm
Resistance tolerance	±5%		
Independent linearity (best straight line) 1.)	±0,25%	±0,25% (±0,2%)	±0,25% (±0,1%)
Theoretical resolution 1.)	Nearly infinite		
Backlash (Hysteresis) 1.)	≤ 2°		
Max. / recommended wiper current 1.)	10 µA / 2 µA		
Power rating @ 70°C (0W @ 105°C)	0,75 W	1 W	2 W
Insulation Voltage 1.)	1000 VAC, 1min		
Insulation Resistance 1.)	100 MOhm @ 1000 VDC		

Mechanical Data, Environmental Conditions, Miscellaneous	3-turn	5-turn	10-turn
Mechanical angle of rotation	1080° +10°	1800° +10°	3600° +10°
Lifetime (90% el. eff. angle half sine) 2.)	2,5 Mio. rotations	5 Mio. rotations	10 Mio. rotations
Max. operational speed	40 rev. / min.		
Bearing	Sleeve bearing		
Operational torque @ ambient temperature 1.) 2.)	5 Nmm		
End stop torque 1.) 2.)	90 Ncm		
Operating temperature range	-55..+105°C		
Storage temperature range	-55..+105°C		
Protection grade (IEC 60529)	IP40		
Protection option D shaft sealing (IEC 60529)	IP65 optional		
Vibration (IEC 68-2-6, Test Fc)	15g 10..2000Hz x 12h		
Shock (IEC 68-2-27, Test Ea)	49g @ 11 ms x 18		
Housing diameter	20 mm		
Housing depth	18 mm	25,5 mm	
Shaft diameter (HH17/19)	6,35 mm (optional 6,00 mm)		
Shaft type	Solid shaft		

# Data Sheet for Precision Potentiometer

Multiturn Hybrid Potentiometer

Series AL24

Mechanical Data, Environmental Conditions, Miscellaneous	3-turn	5-turn	10-turn
Max. radial load		≤1 N	
Max. axial load		≤1 N	
Connection type	Gold plated soldering lugs		
Connection position	Radial		
Sensor mounting	Bushing		
Mass	20 g		25 g
Fastening parts included in delivery	Nut, toothed washer		
Fastening torque mounting nut	150 Ncm		
Material shaft	Stainless steel		
Material housing	Plastic		

1.) According IEC 60393

2.) Determined by climatic conditions according to IEC 68-1, para. 5.3.1 without load collectives

Please note: Max. permissible supply voltage <75 VDC respectively <50 VAC in addition the max. power rating must be observed



# Data Sheet for Precision Potentiometer

Multiturn Hybrid Potentiometer

Series AL24

## Drawing

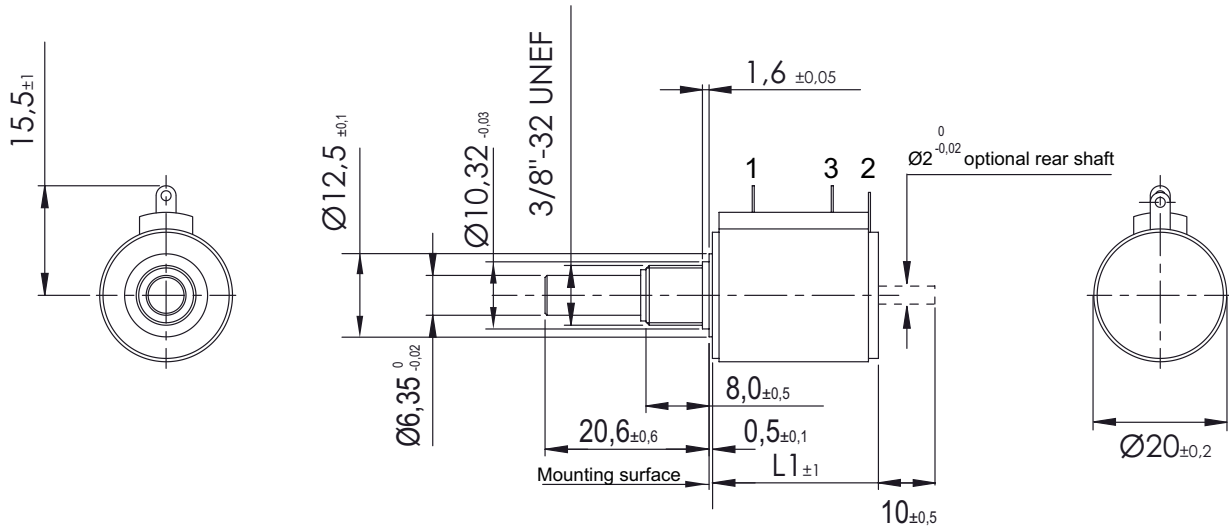

Type	L1	Tandem ±1
AL24 03/05	18	38
AL24 10	25,5	53

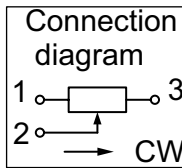

Dimensions in mm

### Option: limit switch

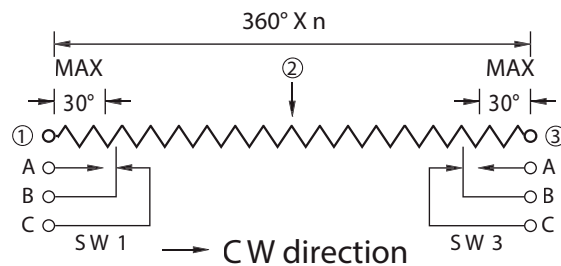
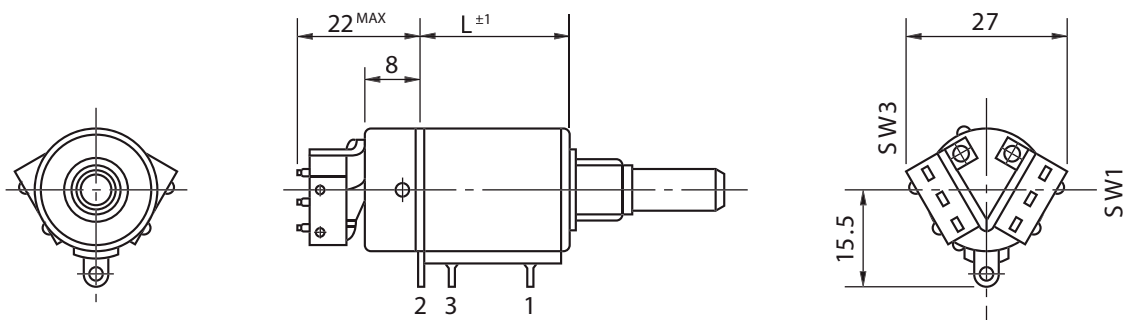

- Unless otherwise specified, the limit-switch is of inscription type on both ends.
- Rating of limit-switch 1A, 125V.A.C. (resistance load)
  - Life expectancy of limit-switch: 50,000 operations
  - Operating temperature range: -55° C..+105° C

### On Request: Special machining on shaft

Slot

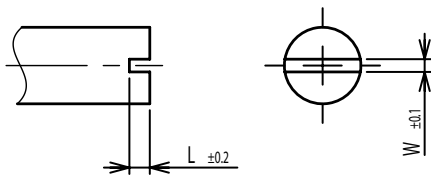

Groove

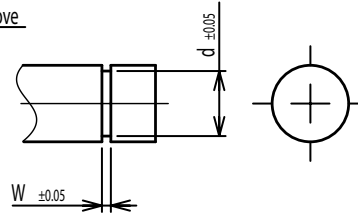

Flat

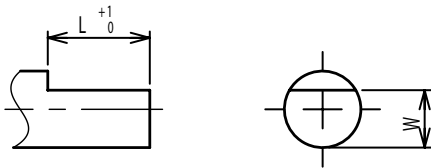

Round top

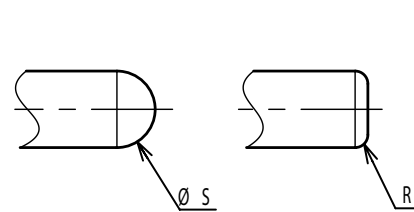

Double side flat

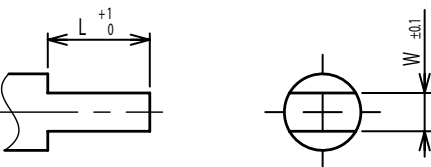

Counterbore hole

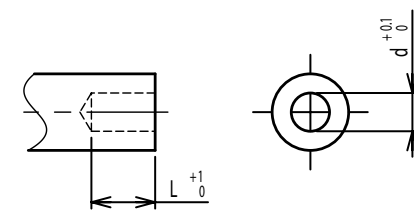

Step

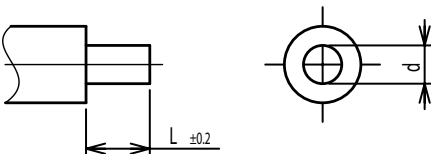

Counterbore screw hole

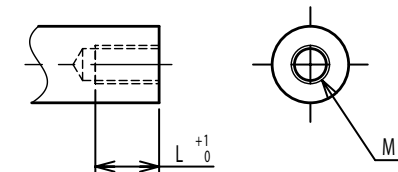

Screw Thread

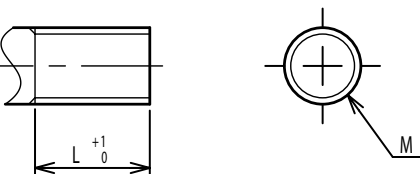

Pin hole

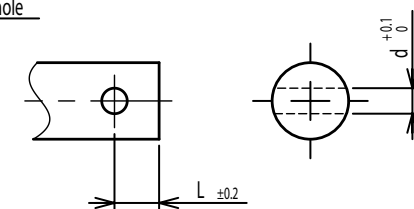

Knurled(Parallel)

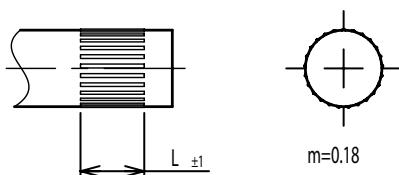

Screw thread inside hole

