

Data Sheet for Precision Potentiometer

Multiturn Hybrid Potentiometer

Series AL11

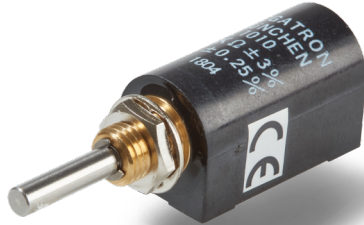

The multiturn potentiometers of the AL11 series in 13 mm housing are suitable for applications that require a miniaturized sensor with long lifespan and low signal noise.

- Miniaturized and precise 10-turn potentiometer
- Versions for direct PCB mounting
- ≥ 10 million revolutions and low signal noise (hybrid technology)

Electrical Data

Effective electrical angle of rotation 1.)	3600° $\pm 5^\circ$
Total resistance 1.)	2..100 kOhm
Resistance tolerance	$\pm 10\%$ ($\pm 5\%$)
Independent linearity (best straight line) 1.)	$\pm 0,4\%$ ($\pm 0,1\%$) [$\pm 0,2\%$ R < 5k]
Theoretical resolution 1.)	Nearly infinite
Backlash (Hysteresis) 1.)	$\leq 2^\circ$
Max. / recommended wiper current 1.)	10 μ A / 2 μ A
Power rating @ 70°C (0W @ 105°C)	1 W
Insulation Voltage 1.)	1000 VAC, 1min
Insulation Resistance 1.)	1000 MOhm @ 500 VDC

Mechanical Data, Environmental Conditions, Miscellaneous

Mechanical angle of rotation	3600° +15°
Lifetime (90% el. eff. angle half sine) 2.)	10 Mio. rotations
Max. operational speed	40 rev. / min.
Bearing	Sleeve bearing
Operational torque @ ambient temperature 1.) 2.)	3 Nmm
End stop torque 1.) 2.)	15 Ncm
Operating temperature range	-55..+105°C
Storage temperature range	-55..+105°C
Protection grade (IEC 60529)	IP40
Protection option D shaft sealing (IEC 60529)	IP65 optional
Vibration (IEC 68-2-6, Test Fc)	15g 10..2000Hz x 12h
Shock (IEC 68-2-27, Test Ea)	49g @ 11 ms x 18
Housing diameter	13 mm
Housing depth	25,5 mm
Shaft diameter	3,175 mm
Shaft type	Solid shaft

Data Sheet for Precision Potentiometer

Multiturn Hybrid Potentiometer

Series AL11

Mechanical Data, Environmental Conditions, Miscellaneous

Max. radial load	≤1 N
Max. axial load	≤1 N
Connection type	soldering lugs / pins
Connection position	Radial
Sensor mounting	Bushing
Mass	ca. 10 g
Fastening parts included in delivery	Nut, toothed washer
Fastening torque mounting nut	< 80 Ncm
Material shaft	Stainless steel
Material housing	Plastic

1.) According IEC 60393

2.) Determined by climatic conditions according to IEC 68-1, para. 5.3.1 without load collectives

Please note: Max. permissible supply voltage <75 VDC respectively <50 VAC in addition the max. power rating must be observed

Order code

Description	Selection: standard=black/bold, possible options=grey/cursive						
Series:	AL11						
Revolutions with stop: 10-turn		10					
Electrical connection: Soldering lugs Soldering pins				- P			
Resistance value: <i>Option 2 kOhm</i> 5 kOhm 10 kOhm <i>Option 20 kOhm</i> <i>Option 50 kOhm</i> <i>Option 100 kOhm</i>				<i>R2k</i> R5k R10k <i>R20k</i> <i>R50k</i> <i>R100k</i>			
Resistance tolerance: ±10% <i>Option ±5%</i>					W10% <i>W5%</i>		
Independent linearity: ±0,4% <i>Option ±0,2% (R < 5kOhm)</i> <i>Option ±0,1%</i>						L0,4% <i>L0,2%</i> <i>L0,1%</i>	
Front shaft: Standard Ø3,175 x 20 mm <i>Option shaft length in mm</i> <i>Option shaft diameter in mm (≤3 mm)</i>							- <i>Ax,xx</i> <i>DMx,xx</i>

For higher quantities or on-going demand, additional options are available as described below on request

For Example: Special axis, tandem / multi-ganged, sealed housing case, special electrical and mechanical angles of rotation, and special resistance and linearity tolerances. Furthermore we can mount gear wheels or attach cable assemblies with or without connectors and much more.

Data Sheet for Precision Potentiometer



Multiturn Hybrid Potentiometer

Series AL11

Drawing

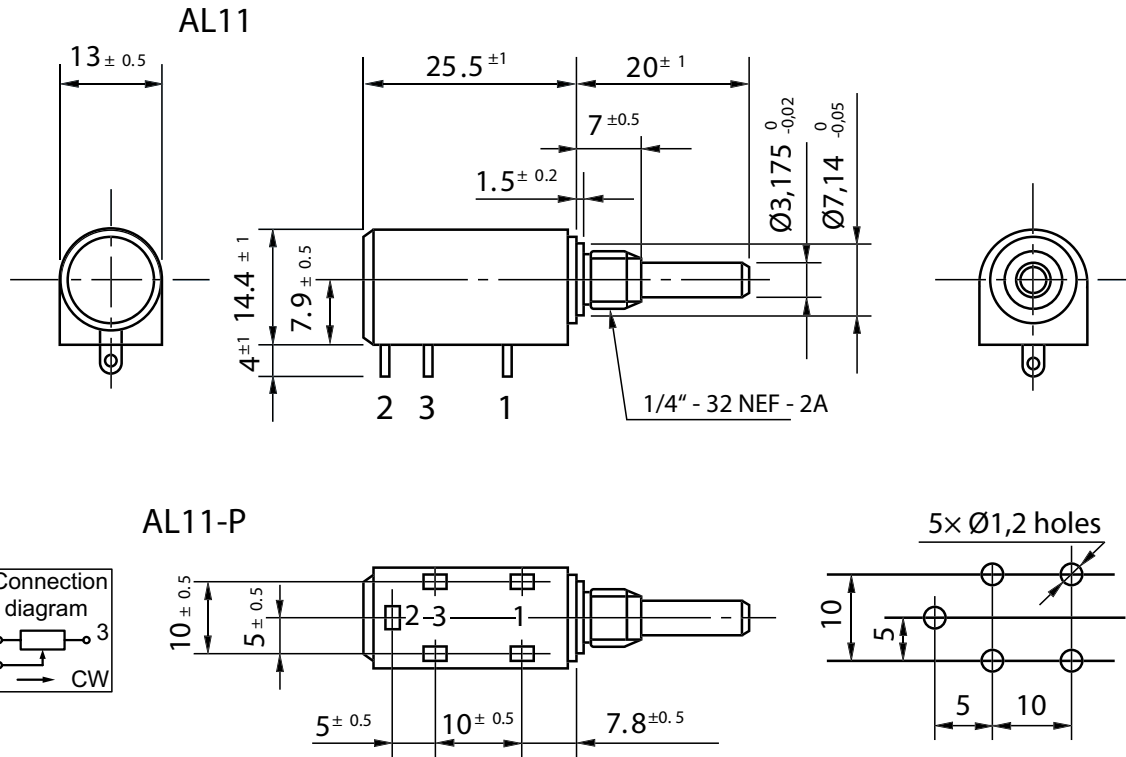

Dimensions in mm

On Request: Special machining on shaft

Slot

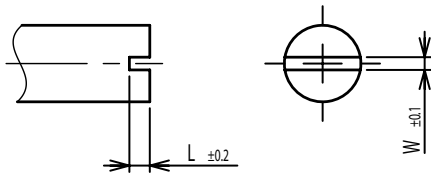

Groove

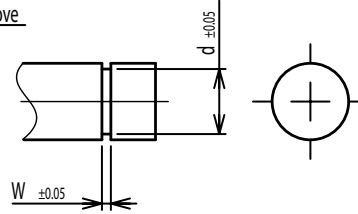

Flat

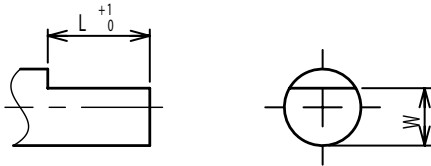

Round top

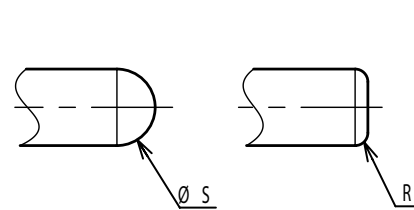

Double side flat

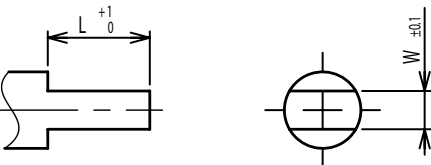

Counterbore hole

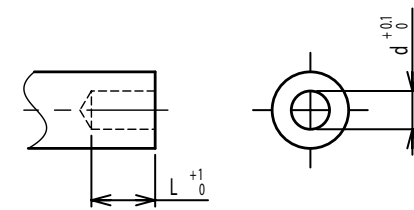

Step

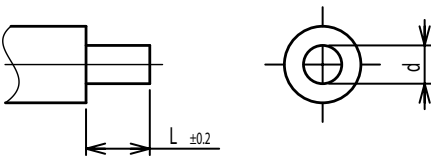

Counterbore screw hole

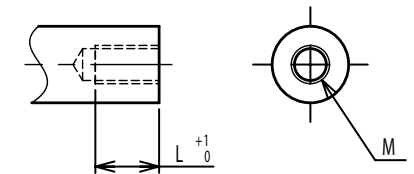

Screw Thread

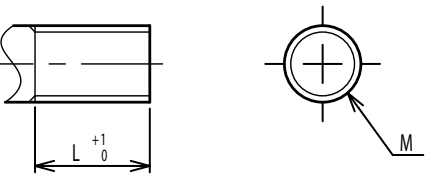

Pin hole

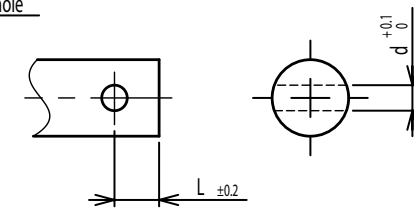

Knurled(Parallel)

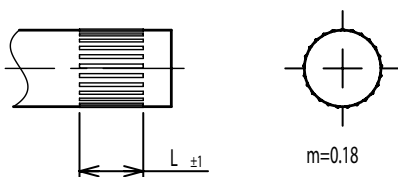

Screw thread inside hole

